

Best™ Integrated Brachytherapy Solutions

More than 60 years have gone into making Brachytherapy more precise, with very few side effects or complications, and excellent clinical outcomes in the treatment of localized cancers.

TeamBest manufactures and provides comprehensive medical devices and accessories needed for a fully integrated Brachytherapy program including: providing assistance setting up, licensing, procurement of equipment, proctoring, reimbursement consulting, patient education and marketing.

In addition, TeamBest can make Brachytherapy treatment more affordable by charging per procedure!

Our Brachytherapy products are manufactured with pride in the USA – providing everything you need from One World • One Source • The Best!

- Ultrasound Imaging Systems
- HDR Remote Afterloaders/Accessories
- LDR/HDR Treatment Planning Systems
- Stepper/Stabilizers
- LDR/HDR Templates
- Radioactive Seeds & Markers
- Needles & Applicators...and more!

Best Medical International, Inc. © 2021

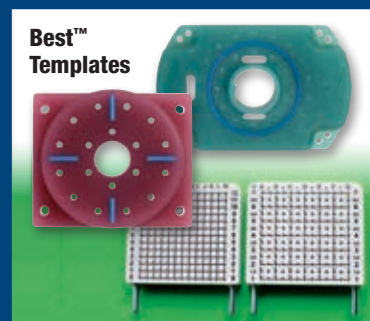

Best Medical International, Inc. 7643 Fullerton Road, Springfield, VA 22153 USA
tel: 703 451 2378 800 336 4970 www.besttotalsolutions.com www.teambest.com

AFRICA | ASIA | EUROPE | LATIN AMERICA | MIDDLE EAST | NORTH AMERICA

* Certain products shown are not available for sale currently.

Best™ Iodine-125 & Palladium-103 Seeds

Think 5
for accuracy!

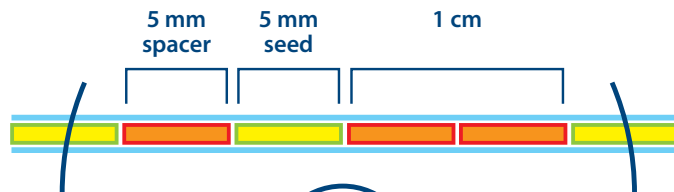

- We manufacture both I-125 and Pd-103 seeds in Springfield, Virginia USA
- Best Medical makes custom seeds and strands to your exact specifications — any source, any configuration, any time!
- Best visualization in ultrasound, fluoro, X-ray, CT and MRI, facilitating real-time dosimetry
- Assistance setting up new programs (licensing, procurement of equipment, proctoring, reimbursement consulting, patient education and marketing)

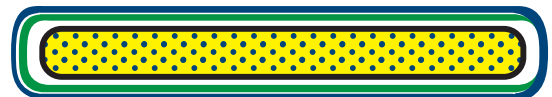

Best™ Iodine-125 Seed

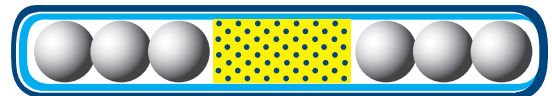

Best™ Palladium-103 Seed

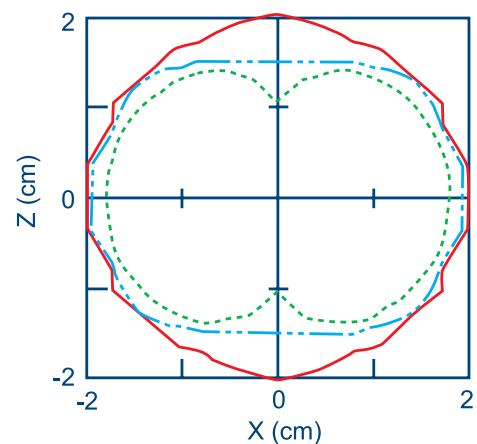

Experimentally Measured Isodose Curves of 20 cGy/h from I-125 Seeds, Best™ Model 2300 Series (solid red line), Model 6702 (broken blue line) and Model 6711 (dotted green line)

*Ravinder Nath and Anthony Melillo
Medical Physics, 20(5), 1480 (1993)*

We ship your order within

24 hours

Sterile and Non-Sterile

BEST MEDICAL

versus

OTHERS

We manufacture both I-125 and Pd-103 seeds in the U.S. and supply directly to hospitals.	Not all of them manufacture both seeds.
Our seeds are made with two titanium capsules. Because of this double-wall encapsulation, our seeds are mechanically strong and can be handled easily with regular forceps.	Use single-wall encapsulation or titanium tube. The seeds sometimes bend or crumble in handling, causing a problem in implantation.
Best I-125 seeds emit pure I-125 spectrum.	Not all of them emit pure I-125 decay scheme spectrum. Some of them emit silver x-rays, thereby lowering the average energy to close to that of Pd-103.
Best's seeds are rated the most isotropic for dosimetry and comply with AAPM and RTOG's dosimetry prerequisites for treatment and clinical trials.	Not all comply with these requirements, and not all seeds are isotropic.
Our seeds are very precise in physical dimensions. They are 5 mm long and 0.8 mm in diameter. Best's seeds fit Mick cartridges snugly and do not jam during implantation.	Seeds vary in length from 4.3 mm to 5 mm. Because of this, Mick cartridges were designed to accommodate up to 5.1 mm seeds, but seed length variation sometimes results in seeds jamming, causing them to rupture.
Spacers are precision made and are 5 mm in length and 0.8 mm in diameter.	Dimensions of spacers from other companies vary.
Our spacers are provided free of charge.	Others may charge for spacers.
Best provides sterile, pre-loaded Mick-style cartridges, needles and strands on short notice.	Not all of them provide on short notice.
Our seeds have the best visualization in ultrasound, fluoro, X-ray, CT, and MRI, facilitating real-time dosimetry.	Seeds do not always have excellent visualization in all media, and real-time dosimetry may not be easily accomplished.
We custom manufacture each order, thereby providing the exact seed activity the customer needs.	Not all of them provide exact activity needed. Customer is limited to a range of seeds available in inventory.
Our packaging is far superior and uses stainless steel containers and sturdy color-coded boxes – Green for Pd-103 and Blue for I-125 seeds.	Use lead containers and do not color-code packaging.
Best has been in Brachytherapy longer than any of its competitors – since 1977. Because of this, we understand patient concerns, the demand for perfection, and the needs of hospital personnel.	Many of them have been in brachytherapy for only a few years.
Best is open 8 am – 7 pm (Eastern Time), M–F. We can send shipments 7 days a week and as late as midnight M–F. We provide an emergency contact number and someone is available 24 hours a day to respond.	Not available.
We help set up new programs with licensing, procurement of necessary equipment, proctoring, reimbursement consulting, patient education, and marketing.	Not all of them provide this support.
Best is considered the “Gold Standard” for customer service and has consistently maintained its excellent reputation throughout its history of serving the Brachytherapy community.	Others are not as good as Best.
Best has a Total Solutions™ program for Prostate Cancer Treatment. We also manufacture Sonalis and TargetScan Ultrasound Systems, Stepper/Stabilizer, Treatment Planning Systems, Brachytherapy Chair/Table, etc.	Others do not.

Best™ Fiducial Marker Kits



Best Medical's Gold Fiducial Markers are available in a variety of diameters and lengths to meet your needs for soft tissue localization such as prostate, liver, pancreas, lung, and breast.

- Best™ Gold Fiducial Markers are available in tissue-absorbable strands
- Standard strand consists of two markers at 2 cm apart center to center
- Special marker strands with custom spacing are also available
- Excellent visualization under X-ray, Fluoro, CT, MRI, Ultrasound and other imaging modalities
- Sold individually, stranded, and in pre-loaded, pre-sterilized needle sets
- Can be used for Brachytherapy, IMRT and IGRT

Best™ Brachytherapy Kit



5 Implant Needles



5 Stylets with Hubs



5 Friction Cuffs



5 Half Moon Buttons*



5 Red Caps

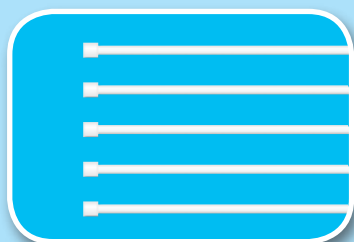
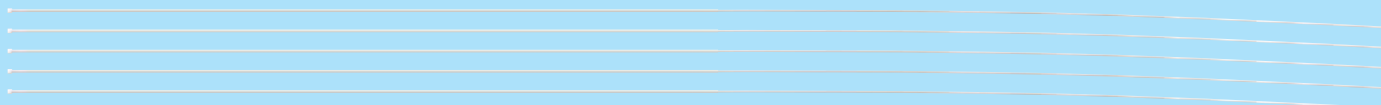

5 Single Leader Catheters**



* Half Moon Buttons are available in radiopaque (pictured) or clear nylon.

** Catheter tubes are available in 4 colors (clear, blue, green or purple) with either radiopaque or clear nylon buttons.

Best[™] Syed Multi-Channel Vaginal Applicator

This novel HDR applicator consists of a disposable central insert and an outer sleeve along with a positioning collar. Source channels in the central insert travel fully to the distal end to allow for optimum dose delivery.

Additionally, the outer sleeve provides a 5 mm wall, to reduce dose to the vaginal mucosa, with a 2 mm wall at the distal end of the applicator to allow for greater dose delivery. The applicator is 18 cm in length with diameters ranging from 2.0 cm to 3.5 cm.

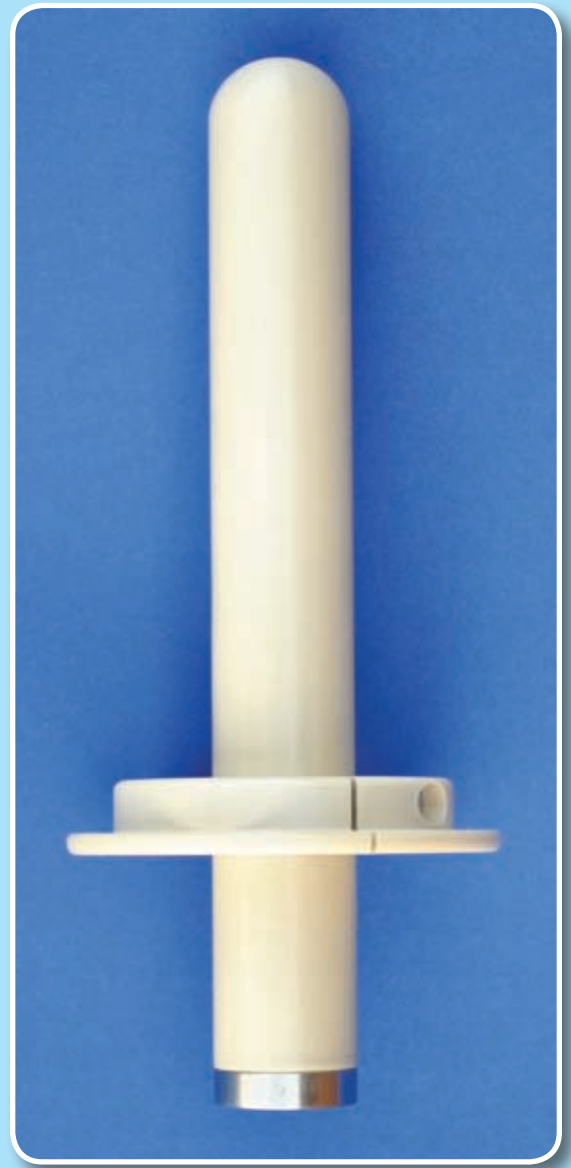

Best™ Syed Brachytherapy Templates

Best Medical offers a wide variety of disposable templates for HDR and LDR applications. Specify hole size when ordering (15, 16 or 17 gauge). These products should be carefully inspected by your staff prior to clinical use and should be used by authorized personnel only.

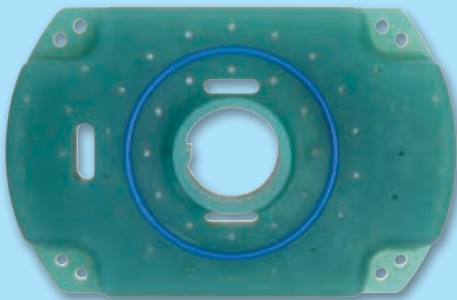

GYN Template (Disposable)

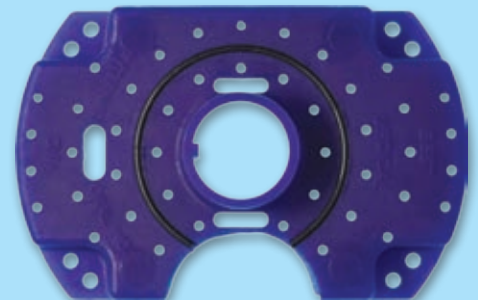

MODIFIED GYN Template (Disposable)

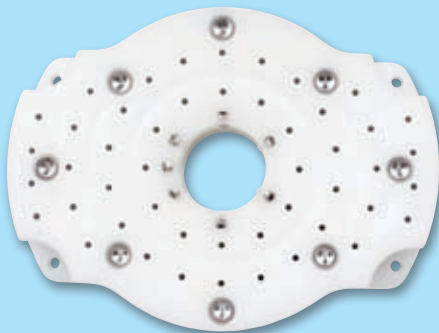

GYN Template

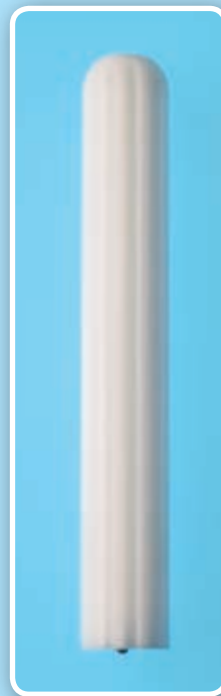

Central Rod

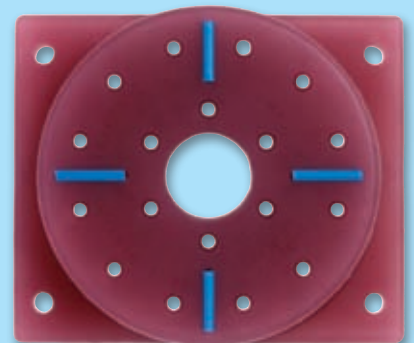

Prostate Template (Disposable)

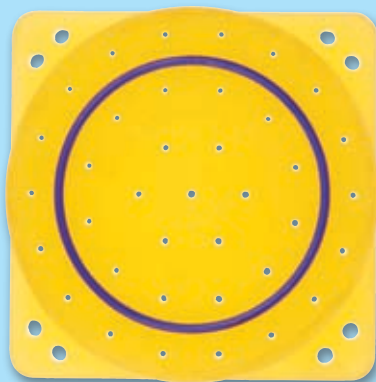

Rectal Template (Disposable)

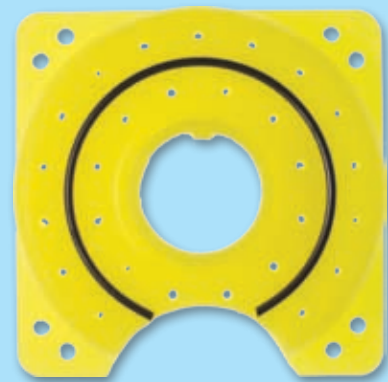

MODIFIED Rectal Template (Disposable)

Best™ X-ray Marker Cables

Best X-ray Marker Cables are indicated for use in HDR brachytherapy procedures. All catheters are available in custom lengths, with or without cable/cable dummy ribbon.

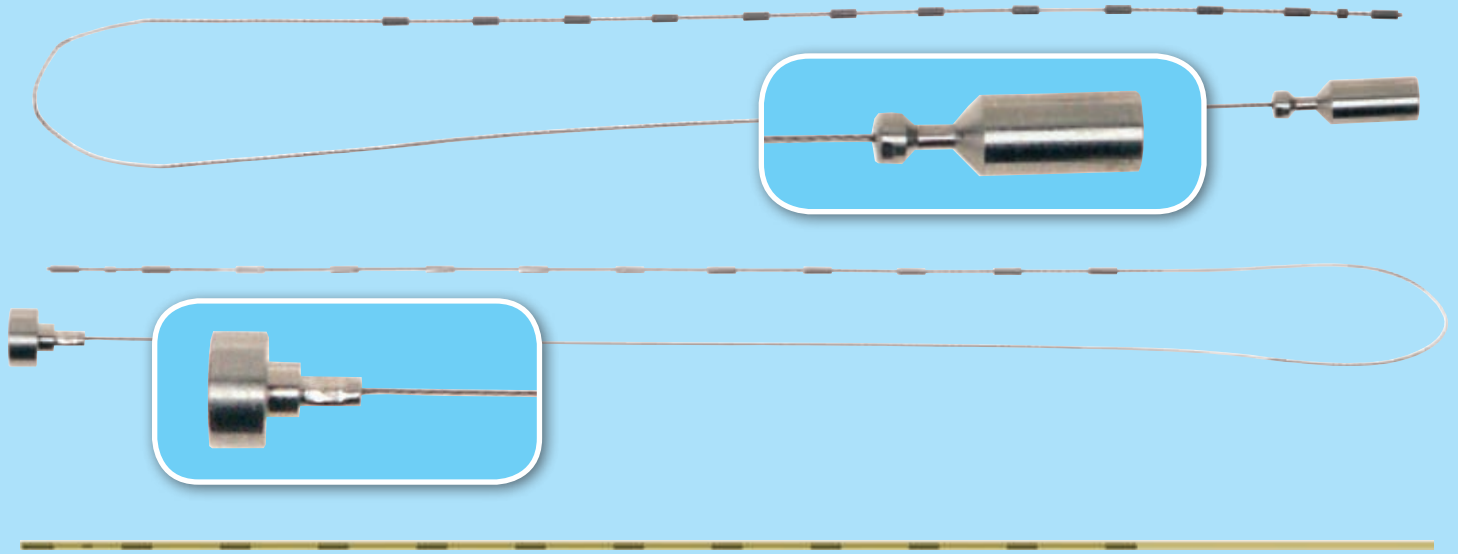

Best™ Prostate Templates

Best Medical International offers a variety of prostate grid templates for all makes and models of steppers, stabilizers and ultrasound systems.

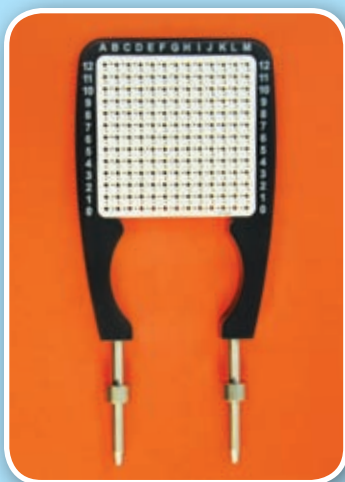

Grid Template
(Disposable)
with Holder
Bracket

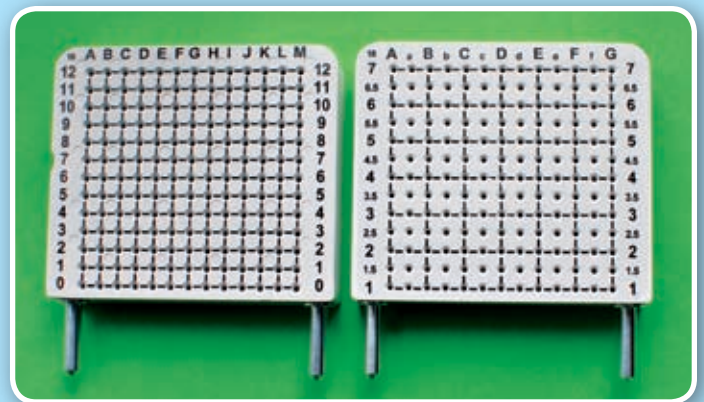

Grid Template for
B-K type (Disposable)